

FLUKE®

1625

Earth/Ground Tester

Getting Started Manual

PN 2560348
January 2006

© 2006 Fluke Corporation, All rights reserved. Printed in USA
All product names are trademarks of their respective companies.

LIMITED WARRANTY AND LIMITATION OF LIABILITY

Each Fluke product is warranted to be free from defects in material and workmanship under normal use and service. The warranty period is two years and begins on the date of shipment. Parts, product repairs, and services are warranted for 90 days. This warranty extends only to the original buyer or end-user customer of a Fluke authorized reseller, and does not apply to fuses, disposable batteries, or to any product which, in Fluke's opinion, has been misused, altered, neglected, contaminated, or damaged by accident or abnormal conditions of operation or handling. Fluke warrants that software will operate substantially in accordance with its functional specifications for 90 days and that it has been properly recorded on non-defective media. Fluke does not warrant that software will be error free or operate without interruption.

Fluke authorized resellers shall extend this warranty on new and unused products to end-user customers only but have no authority to extend a greater or different warranty on behalf of Fluke. Warranty support is available only if product is purchased through a Fluke authorized sales outlet or Buyer has paid the applicable international price. Fluke reserves the right to invoice Buyer for importation costs of repair/replacement parts when product purchased in one country is submitted for repair in another country.

Fluke's warranty obligation is limited, at Fluke's option, to refund of the purchase price, free of charge repair, or replacement of a defective product which is returned to a Fluke authorized service center within the warranty period.

To obtain warranty service, contact your nearest Fluke authorized service center to obtain return authorization information, then send the product to that service center, with a description of the difficulty, postage and insurance prepaid (FOB Destination). Fluke assumes no risk for damage in transit. Following warranty repair, the product will be returned to Buyer, transportation prepaid (FOB Destination). If Fluke determines that failure was caused by neglect, misuse, contamination, alteration, accident, or abnormal condition of operation or handling, including overvoltage failures caused by use outside the product's specified rating, or normal wear and tear of mechanical components, Fluke will provide an estimate of repair costs and obtain authorization before commencing the work. Following repair, the product will be returned to the Buyer transportation prepaid and the Buyer will be billed for the repair and return transportation charges (FOB Shipping Point).

THIS WARRANTY IS BUYER'S SOLE AND EXCLUSIVE REMEDY AND IS IN LIEU OF ALL OTHER WARRANTIES, EXPRESS OR IMPLIED, INCLUDING BUT NOT LIMITED TO ANY IMPLIED WARRANTY OF MERCHANTABILITY OR FITNESS FOR A PARTICULAR PURPOSE. FLUKE SHALL NOT BE LIABLE FOR ANY SPECIAL, INDIRECT, INCIDENTAL OR CONSEQUENTIAL DAMAGES OR LOSSES, INCLUDING LOSS OF DATA, ARISING FROM ANY CAUSE OR THEORY.

Since some countries or states do not allow limitation of the term of an implied warranty, or exclusion or limitation of incidental or consequential damages, the limitations and exclusions of this warranty may not apply to every buyer. If any provision of this Warranty is held invalid or unenforceable by a court or other decision-maker of competent jurisdiction, such holding will not affect the validity or enforceability of any other provision.

Fluke Corporation
P.O. Box 9090
Everett, WA 98206-9090
U.S.A.

Fluke Europe B.V.
P.O. Box 1186
5602 BD Eindhoven
The Netherlands

Table of Contents

Title	Page
Introduction	1
Description of the Operating Elements	3
Description of Display Elements	5
Procedure of Measurements	6
POWER ON Functions	7
Operation	8
Checking of Correct Measuring Connection (Socket Allocation) ..	8
Safety Control Measurements	9
Measurement of Interference - Voltages and Frequencies	9
Measurement of Earthing Resistances	10
3-pole/4-pole Measurement of Earthing Resistance	11
Measurement of Single Earth Electrode Resistances in Mesh Operated Earthing Systems Using Selective Clamp Method ..	14
3-pole/4-pole Measurement of Single Earth Electrode Resistances	15
Measurements on High Voltage Pylons	17
Compensation of Earth Electrode Connecting Lead	20
Measurement of Soil Resistivity	21
Measurement of Resistances	23
Resistance Measurement (R_{\sim})	23
Resistance measurement (R_{\rightarrow})	24
Compensation of Measuring Lead Resistance	26
Description of Displays	27
Stakeless Earth/Ground Resistance Testing	31
Introduction	31
Principle of Operation	32
Operation	34
Applications	36

List of Tables

Table	Title	Page
1.	Description of Displays.....	27

List of Figures

Figure	Title	Page
1.	Fluke 1625 Earth/Ground Tester.....	2
2.	Operating Elements.....	3
3.	Display Elements.....	5
4.	Measurement of Interference - Voltages and Frequencies.....	10
5.	Earthing Resistances Measurement - Method.....	11
6.	3-pole/4-pole Measurement of Earthing Resistance - Process.....	12
7.	Earth Resistance - Maximum Permissible Value.....	13
8.	Measurement of Single Earth Electrode Resistances in Mesh Operated Earthing Systems.....	14
9.	3-pole/4-pole Measurement of Single Earth Electrode Resistances.....	15
10.	Measuring the Earthing Resistance without Disengaging the Overhead Earth Wire.....	18
11.	Compensation of Earth Electrode Connecting Lead.....	20
12.	Measurement of Soil Resistivity.....	21
13.	Resistance Measurement (R_{\sim}).....	24
14.	Resistance measurement ($R_{\overline{\sim}}$).....	25
15.	Evaluation of Measured Value.....	26
16.	Compensation of Measuring Lead Resistance.....	26

Earth/Ground Tester

Introduction

At locations involving the generation, distribution and consumption of electrical energy, certain safety measures must be met in order to protect human life. In many cases, these safety measures are national and international regulations which must be checked regularly. Grounding, the connection of exposed conductive parts to the earth in case of a fault, represents the most fundamental safety measure. There are requirements for grounding of transformers, high and medium voltage power pylons, railway tracks, tanks, vats, foundations and lightning protection systems.

The effectiveness of grounding systems should be checked using a ground test instruments such as the 1625 which checks the effectiveness of connections to the ground. The 1625 provides the perfect solution by combining the latest technology into a compact, field-rugged and extremely easy to use instrument. In addition to performing standard 3- and 4-pole ground resistance measurements, an innovative process accurately measures individual earth electrode resistances in single and meshed earthed systems without disconnecting any parallel electrodes. One specific application of this capability is quick and accurate measurement of power pylon grounds. The 1625 also incorporates automatic frequency control (AFC) to minimize interference. Before measuring, the instrument identifies existing interference and selects a measurement frequency to minimize its effect. The 1625 incorporates microprocessor controlled automatic measurements including checking probe hookup to ensure that measurements are taken correctly. It measures all probe ground resistances to ensure reliable, repeatable results. Probe resistance and auxiliary earth resistance are also measured and displayed.

Notes

- *The terms earth and earthing also refer to ground and grounding and is used interchangeably throughout this manual.*
- *For stakeless earth resistance measurements, the EI-1625 must be purchased. (The EI-1625 comes standard with the 1625 Kit). Refer to Appendix A for a complete set of operating information including specifications.*
- *Selective measurements are described in the main section of this manual.*

Figure 1 displays the Fluke 1625 Earth/Ground Tester:

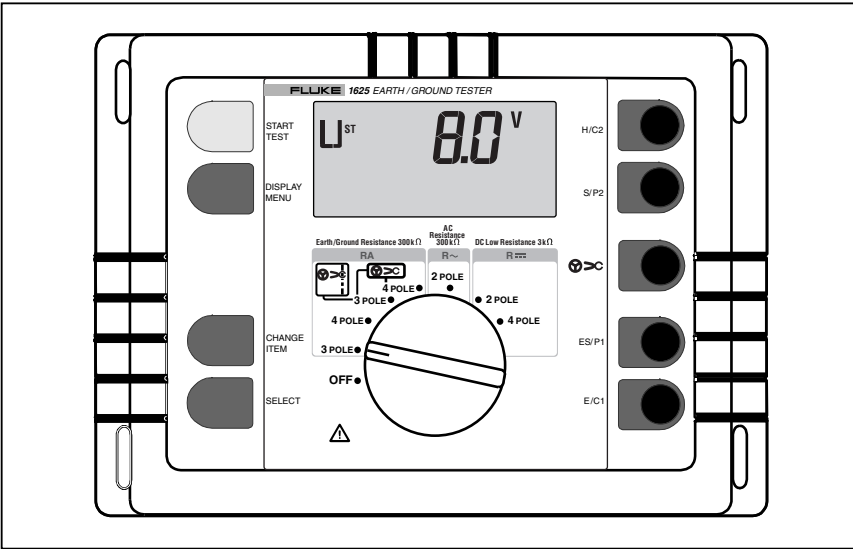

Figure 1. Fluke 1625 Earth/Ground Tester

edw001.eps

Description of the Operating Elements

Figure 2 illustrates the operating elements described below.

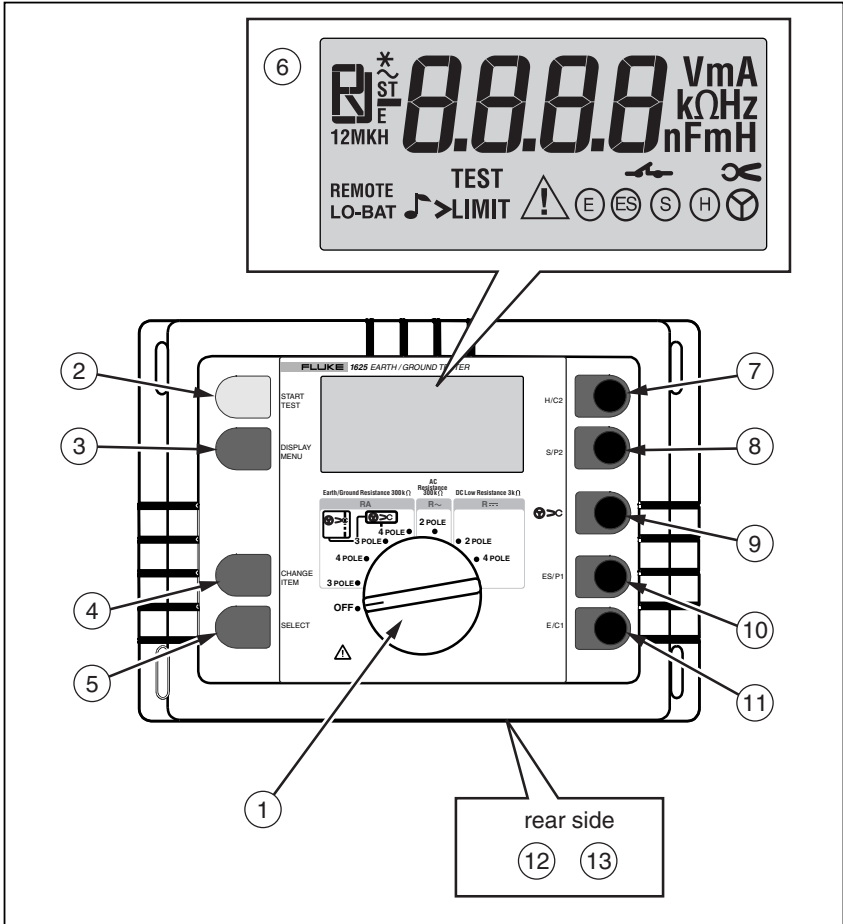

Figure 2. Operating Elements

edw006.eps

- ① Central rotary switch to select measuring function or switch ON/OFF
- ② "START TEST"-button to start the set measuring function.
- ③ "DISPLAY MENU"-button to call corresponding supplementary values.
- ④ "CHANGE ITEM" button to change the set point entry values.

- ⑤ "SELECT" button to select the digit to be changed.
- ⑥ Display unit has 18 mm high liquid crystal digits with automatic decimal point as well as active illumination.
- ⑦ Connecting socket (H) (auxiliary earth electrode) (4 mm \varnothing) also usable with safety measuring lead
- ⑧ Connecting socket (S) (probe) (4 mm \varnothing) also usable with safety measuring lead.
- ⑨ Connecting socket for an ext. clip-on current transformer (optional).

⚠ Warning

No voltage permissible to sockets (E) (ES) (S) (H) .

- ⑩ Connecting socket (ES) (earthing probe) (4 mm \varnothing) also usable with safety measuring lead. Potential pick off with 4-pole earthing measurement.
- ⑪ Connecting socket (E) (earth electrode) (4 mm \varnothing) also usable with safety measuring lead.

⚠ Attention

Do not open or close the instrument with force!

- ⑫ Battery compartment for: 6 x IEC LR6 batteries or type AA batteries.

⚠ Warning

Disconnect all leads before opening the instrument!

- ⑬ Screws to fasten the battery compartment

Description of Display Elements

The display (Figure 3) is divided into four display elements:

1. Digital display of measured value
2. Measuring function field to display measuring function
3. Unit field: V, Ω , k Ω , Hz
4. Special characters for operator guidance

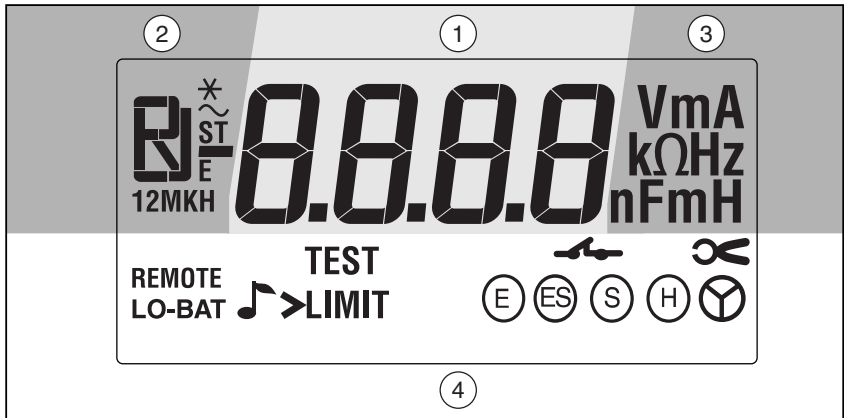





Figure 3. Display Elements

edw008.eps

Description of display symbols:

U_{ST}	Interference voltage (AC + DC)
F_{ST}	Frequency of interference voltage
F_M	Frequency of measuring voltage
U_M	Measuring voltage limit 20/48 V
R_E	Earthing resistance
R_H	Auxiliary earth electrode resistance
R_S	Probe resistance
R_K	Compensation resistance
R_1, R_2	Low voltage measurement with polarity indication

R ~	AC- resistance
R*	Earthing impedance (measuring frequency 55 Hz)
AFC	Automatic-frequency-control
TEST	Measuring sequence in process
LIMIT	Limit value
> LIMIT	Limit value exceeded
	Socket recognition
	Recognition of current transformer socket
	Message of an exceeded limit with beeper
LO-BAT	Battery voltage too low, replace batteries.
REMOTE	Interface (optional) active - button operation locked
	Measuring circuit (E-S,E-H) interrupted or measured value instable

 Warning**Refer to Operating Instructions.*****Procedure of Measurements***** Warning****Use the instrument on voltage free systems only.**

1. Set measuring function with the central rotary switch ①
2. Connect instrument without measuring lead connected START is omitted
3. Start measurement with "START TEST" button.
4. Read out measured value.

For optimum performance and utilization of the device observe the following points:

POWER ON Functions

During switching on of the instrument with the central rotary switch it is possible to access certain operating conditions by pressing certain button combinations:

a) Standard mode

If the device is put into operation without further button control, it switches into a battery saving condition (Stand by-display "---") approx. 50 seconds after the termination of a measurement, or after a button push or turn of the rotary switch. Pressing the "DISPLAY MENU" reactivates the instrument; the "old" measured values can be read out again. After 50 min. of stand by the Display is turned off completely. Instrument is reactivated with ON / OFF on the rotary switch

b) Stand by disable

A simultaneous push of buttons "DISPLAY MENU" and "CHANGE ITEM" during switching on prevents the instrument from being switched off automatically (Stand by). The battery saving mode is reactivated with ON / OFF on the central rotary switch.

c) Prolonged display test

By keeping the "DISPLAY MENU" button pressed during switching on, the display test can be prolonged for any length of time. Return to the standard operation mode by pressing any button or turning of the central rotary switch.

d) Number of software version

By keeping the "SELECT" button pressed during the switch on sequence, the number of the software version is indicated on the display. By pressing the "DISPLAY MENU" button a switch over to the last calibration date is possible. This display sequence is terminated by turning the central rotary switch or pressing the "START TEST" button.

Display format:	SOFTWARE-version:	X . X X
	Date of calibration:	M M . J J

Note

At delivery the date of calibration is set to 0.00. Only after the first recalibration a proper date is indicated.

e) Activation of display illumination

By keeping the "CHANGE ITEM" button pressed during the switch on sequence the display illumination is activated. Illumination fades away automatically if the instrument is switched to "Stand by" and, together with the instrument, is switched on again by pressing any button. The instrument is switched off with ON/OFF on the central rotary switch exclusively.

Operation

The measuring functions have two initial operational modes: the Control loop and the Measuring loop. The following discussion applies to the Measuring Loop

Measuring Loop

This loop is entered by pressing the "START TEST" button. After releasing "START TEST" the last measured value stays on the display. By repeated pressing of the "DISPLAY MENU" button all supplementary values can be called. If a measured value exceeds or falls below the pre-set limit, the limit can be displayed as well (with "DISPLAY MENU"). In that case the measured value is displayed with a flashing "LIMIT" whereas the limit value is displayed with a steady "LIMIT"-symbol.

Inside the measuring loop parameters cannot be changed.

Further possibilities of button operation:

Warning sound (🔊) cancel with "DISPLAY MENU" (with display switchover) or with "CHANGE ITEM" or "SELECT" button (without display switchover).

Checking of Correct Measuring Connection (Socket Allocation)

The instrument implements an automatic check, corresponding to the measurement selected, to see if the correct input sockets are used.

The display symbols E ES S H and Y >C are assigned to a specific socket as shown in Figure 4.

From the way the symbols are displayed, the validity of the connected wiring can be concluded by the following features:

- socket incorrectly wired (or, by mistake, not wired): corresponding symbol flashes.
- socket correctly wired: corresponding symbol is steady active
- socket with no connection: corresponding symbol is blank

Safety Control Measurements

Before each measurement the instrument automatically checks the measuring conditions and, while simultaneously displaying the kind of error, prevents measurements from being started under the following conditions:

- excessive voltage on the sockets ($> 24 \text{ V}$ in RE and R~; $> 3 \text{ V}$ in R $\overline{\text{---}}$)
- wrong or incomplete connection
- Problems during the measuring sequence (display "E1 ... E5") see display description in the section 'Procedure of Measurements'.
- Battery voltage too low (display LO-BAT)

Measurement of Interference - Voltages and Frequencies

This measuring function detects possible interference voltages and their frequencies. This function is automatically active in every switch position before an earthing or resistance measurement. If the pre-set limit values are exceeded, the interference voltage is indicated as too high and a measurement automatically prevented. The frequency of an interference voltage is only measurable if the level of this interference voltage is higher than 1 V. See Figure 4.

Bring central rotary switch in desired position, read out measured value of interference voltage, measured value of interference frequency is displayed with "DISPLAY".

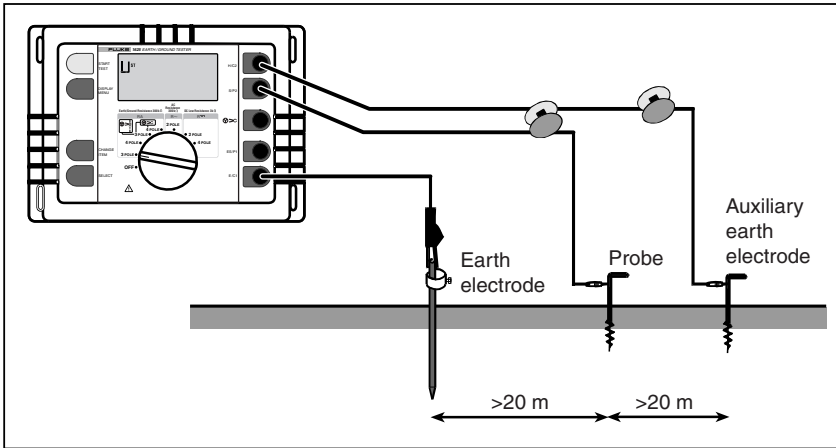

edw010.eps

Figure 4. Measurement of Interference - Voltages and Frequencies

Measurement of Earthing Resistances

This instrument is equipped with a 3 pole as well as a 4 pole resistance measurement which renders measurements of resistances of earthing systems possible, as well as measurements of the soil resistivity of geological strata. A specific description of the different applications is given further on in this manual. As a special function, the instrument offers measurements with an external current transformer, with which a measurement of single resistance branches in interlinked networks (lightning protection and high voltage pylons with cabling) can be performed without separating parts of the system.

To ensure most feasible interference suppression during measurements, the instrument is equipped with 4 measuring frequencies (94 Hz, 105 Hz, 111 Hz, 128 Hz), with automatic switch over if necessary (AFC - Automatic Frequency Control). The corresponding measuring frequency used for a specific measurement can be called and displayed with "DISPLAY MENU" after the measurement. Additionally, one of the four measuring frequencies can be selected and permanently set in special cases. In that case, in order to stabilize the display, an average measurement can be carried out for up to 1 minute by keeping the "START TEST" button pressed.

To determine the earthing impedance (R^*) a measurement with a frequency close to the mains frequency (55 Hz) is carried out. At the activation of R^* through user's code, this measuring frequency is activated automatically.

To keep the instrument as simple as possible at the time of delivery, all special functions, such as LIMIT input, BEEPER programming, measurement of earthing impedance (R^*) etc, are not activated at delivery. They can be activated with personalized user's code (see "Changing of all Pre-set Data with Personalized Code"). Refer to Figure 5.

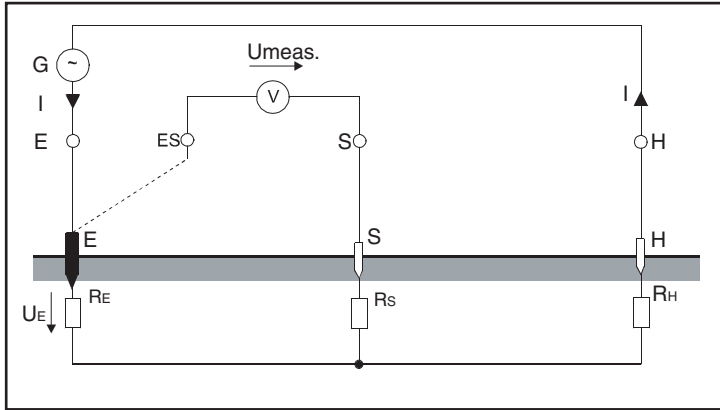
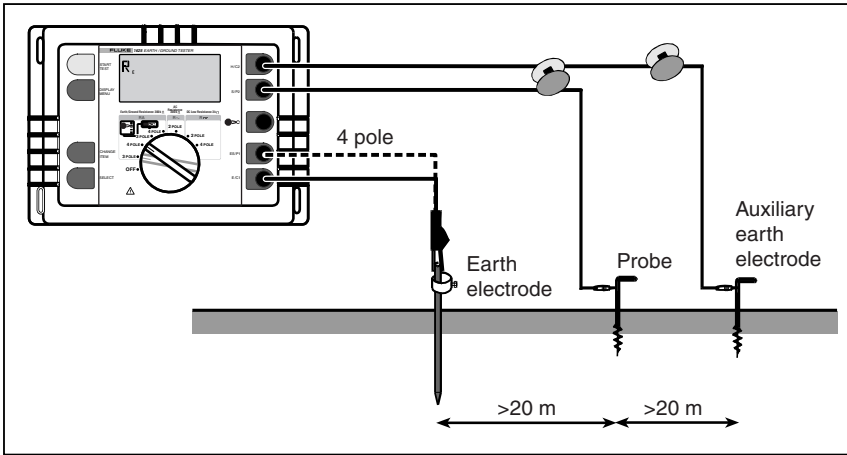

Figure 5. Earthing Resistances Measurement - Method

edw011.eps

3-pole/4-pole Measurement of Earthing Resistance

This measuring function measures earthing and earth dissipation resistances of single earth electrodes, foundation earth electrodes and other earthing systems by using 2 earth spikes. See Figure 6.



edw012.eps

Figure 6. 3-pole/4-pole Measurement of Earthing Resistance - Process

1. Turn central rotary switch to position " R_E 3pole" or " R_E 4pole"

The instrument is to be wired according to picture and notices given on the display.

A flashing of the sockets symbols E ES S H or X , points to an incorrect or incomplete connection of the measuring lead.

2. Press "START TEST" button

Now a fully automated test sequence of all relevant parameters like auxiliary earth electrode, probe- and earth electrode resistance is implemented and finished with the display of the result R_E .

3. Read out measured value R_E
4. Call R_S and R_H with "DISPLAY MENU".

Remarks for the setting of earth spikes:

Before setting the earth spikes for probe and auxiliary earth electrode make sure that the probe is set outside the potential gradient area of earth electrode and auxiliary earth electrode (also see "The Influence of Potential Gradient areas on Earth Resistance Measurement"). Such a condition is normally reached by allowing a distance of > 20 m between the earth electrode and the earth spikes as well as of the earth spikes to each other.

An accuracy test of the results is made with another measurement following repositioning of the auxiliary earth electrode or probe. If the value stays the

same, the distance is sufficient. If the measured value changes, probe or auxiliary earth electrode must be repositioned until the measured value R_E stays constant.

Spike wires should not run too close to each other.

3-pole measurement with longer earth electrode connecting leads

Use one of the accessory cable drums as earth electrode connecting lead. Spool off cable completely and compensate line resistance as described in “Compensation of Earth Electrode Connecting Lead”.

Time average measurement:

If there is a warning "measured value unstable" (see “Procedures of Measurement”, “Description of display”) after a test sequence, most likely it is caused by strong interference signals (e.g. unsteady noise voltage). Nevertheless, to get reliable values, the instrument offers the possibility of averaging over a longer period.

1. Select a fixed frequency (see “Control loop” in “Operation”)
2. Keep the "START TEST" button pressed until the warning "measured value unstable" disappears. Max. Averaging time is approx. 1 min.

Evaluation of measured value:

Figure 7 shows the maximum permissible value of the Earth resistance which will not exceed a permissible limit value, taking into account the maximum usage error.

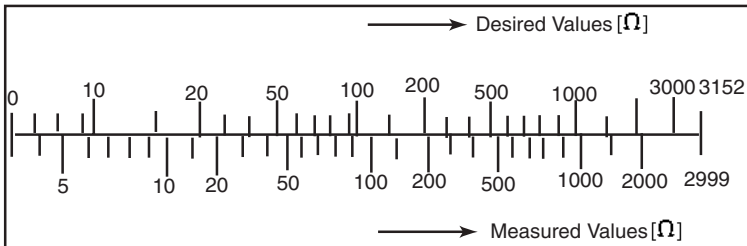

Figure 7. Earth Resistance - Maximum Permissible Value

edw013.eps

Measurement of Single Earth Electrode Resistances in Mesh Operated Earthing Systems Using Selective Clamp Method

This measuring method has been created to measure single earth electrodes in permanently wired or mesh operated systems (e.g. lightning protection system with several electrodes or high voltage pylons with earth cabling etc.). By measuring the actual current flow through the earth electrode, this special measuring method provides the unique possibility to measure selectively only this particular resistance by means of a clip-on transformer (accessory). Other parallel resistances applied are not taken into account and do not distort the measuring result. See Figure 8.

A disconnection of the earth electrode before the measurement is therefore no longer necessary.

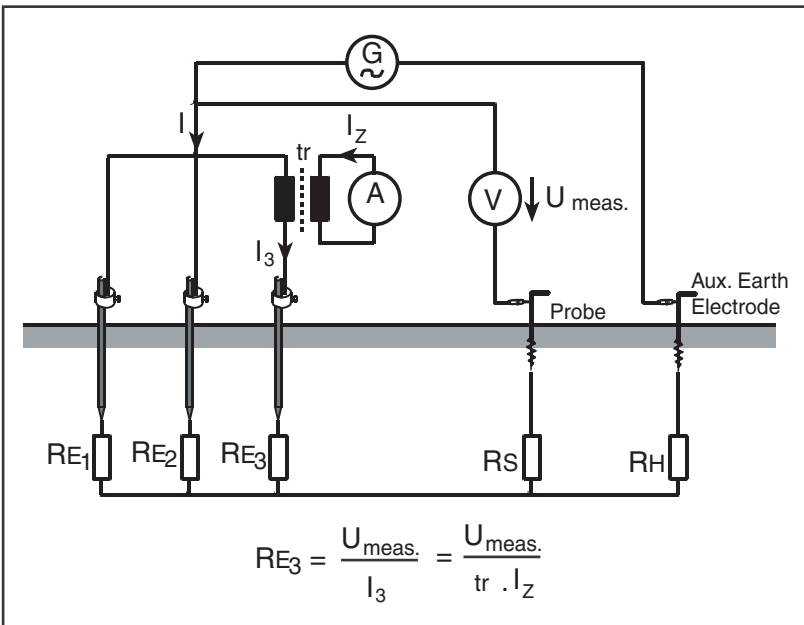

edw014.eps

Figure 8. Measurement of Single Earth Electrode Resistances in Mesh Operated Earthing Systems

Errors of the current transformer can be corrected as described in “Correcting Clip-on Transformer Error”.

3-pole/4-pole Measurement of Single Earth Electrode Resistances

See Figure 9. Turn central rotary switch to position "∞ RE 3pole" or "∞ RE 4pole". The instrument is to be wired according to picture and notices given on the display.

A flashing of the sockets symbols (E) (ES) (S) (H) or ∞, points to an incorrect or incomplete connection of the measuring lead.

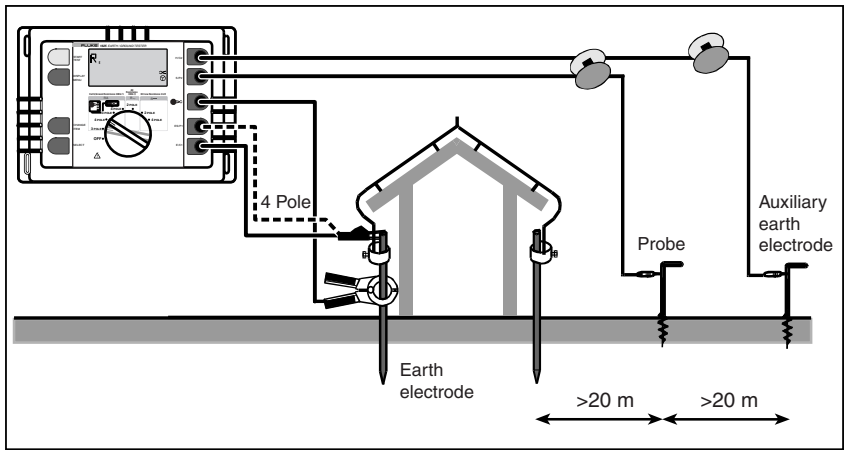

edw015.eps

Figure 9. 3-pole/4-pole Measurement of Single Earth Electrode Resistances

Fix clip-on transformer around the earth electrode to be measured.

Make sure that the clip-on transformation ratio set on the instrument corresponds to the clip-on transformer used. Change settings if necessary (see "Changing of all Data Settings with Personalized CODE")

Note

The ratio that is preset from factory is correct for the EI162X sensing clamp

Press "START TEST" button.

Now a fully automated test sequence of all relevant parameters like auxiliary earth electrode, probe- and earth electrode resistance is implemented and finished with the display of the result R_E .

1. Read out measured value R_E
2. Call R_S and R_H with "DISPLAY MENU".

Remarks for the Setting of Earth Spikes

Before setting the earth spikes for probe and auxiliary earth electrode make sure that the probe is set outside the potential gradient of earth electrode and auxiliary earth electrode (also see "The Influence of Potential Gradient areas on Earth Resistance Measurement"). Such a condition is normally reached by allowing a distance of >20 m between the earth electrode and the earth spikes as well as to the earth spikes to each other. An accuracy test of the results is made by another measurement following repositioning of the auxiliary earth electrode or probe. If the value stays the same, the distance is sufficient. If the measured value changes, probe or auxiliary earth electrode must be repositioned until the measured value R_E stays constant.

Spikes wires should not run too close.

3-pole Measurement with Longer Earth Electrode Connecting Leads

1. Use one of the accessory cable drums as earth electrode connecting lead.
2. Spool off cable completely and compensate line resistance as described in "Compensation of Earth Electrode Connecting Lead".

Time Average Measurement

If there is a warning "measured value unstable" (see "Description of Displays", Procedure of Measurements) after a test sequence, most likely it is caused by strong interference signals (e.g. unsteady noise voltage). Nevertheless, to get reliable values, the instrument offers the possibility of averaging over a longer period.

1. Select a fixed frequency (see "Control loop", Operation)

2. Keep the "START TEST" button pressed until the warning "measured value unstable" disappears. Max. averaging time is approx. 1 min.

Measurements on High Voltage Pylons

Measuring the Earthing Resistance without Disengaging the Overhead Earth Wire Using the Selective Clamp Method

The measurement of the earth resistance of a single high voltage pylon usually requires the overhead earth wire to be disengaged (lifted off) or the separation of the earthing system from the pylon construction. Otherwise false reading of the resistance of the pylon earth electrode are liable to occur because of the parallel circuit of the other pylons connected to each other by an overhead earth wire.

The new measuring method employed in this instrument - with its external current transformer to measure the true current flowing through the earth electrode - allows measurements of earth electrode resistances without disconnection of the earthing system or disengaging the overhead earth wire.

As all four pylon stubs are connected to the foundation earth of the pylon, the measuring current I_{meas} is divided into five components according to the present resistances involved.

One part flows via pylon construction to the overhead earth wire and further to the parallel circuited pylon earthing resistances.

The other four current components ($I_1... I_4$) flow via the individual pylon foots.

The addition of all currents result in a current I_E going through the earthing resistance, i.e. the resistance of the "composite" earth electrode to the soil.

If the current transformer is fixed to each pylon stub, one after the other, four resistances have to be measured which show a behavior inversely proportional to the corresponding current components $I_1 ... I_4$. The feeding point of the measuring current is to be left unchanged to avoid a change in the current distribution.

Accordingly, these equivalent resistances are displayed as:

$$R_{Ei} = \frac{U_{meas}}{I_i}$$

Therefore the earthing resistance R_E of the pylon is determined as a parallel circuit of the individual equivalent resistances:

$$R_E = \frac{1}{\frac{1}{R_{E1}} + \frac{1}{R_{E2}} + \frac{1}{R_{E3}} + \frac{1}{R_{E4}}}$$

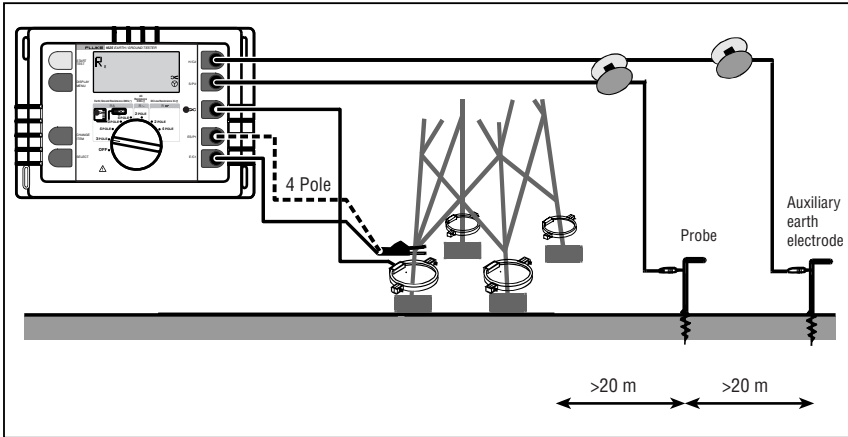

edw016.eps

Figure 10. Measuring the Earthing Resistance without Disengaging the Overhead Earth Wire

1. Turn central rotary switch to position " ∞R_E 3pole" or " ∞R_E 4pole". The instrument is to be wired according to picture and notices given on the display.

A flashing of the sockets symbols E ES S H or Y ∞ , points to an incorrect or incomplete connection of the measuring lead.

2. Apply current transformer to the pylon stub. Make sure that the transformation ratio set on the instrument corresponds to the current transformer used. Change settings if necessary (see "Changing of All Data Settings with Personalized CODE")
3. Press "START TEST" button

Now a fully automated test sequence of all relevant parameters like auxiliary earth electrode, probe- and earth electrode resistance is implemented and finishes with the display of the result R_E .

4. Read out measured value R_E
5. Call R_S and R_H with "DISPLAY MENU".

Notices for the setting of earth spikes:

Before setting the earth spikes for probe and auxiliary earth electrode make sure that the probe is set outside the potential gradient of earth electrode and auxiliary earth electrode (see also "The Influence of Potential Gradient Areas on Earth Resistance Measurement"). Such a condition is normally reached by allowing a distance of >20 m between the earth electrode and the earth spikes as well as to the earth spikes to each other. An accuracy test of the results is made with another measurement after repositioning of auxiliary earth electrode or probe. If the result is the same, the distance is sufficient. If the measured value changes, probe or auxiliary earth electrode must be repositioned until the measured value R_E remains constant. Spike wires should not run too close.

1. Apply current transformer to next pylon stub.
2. Repeat measuring sequence.

Current feeding point of measuring current (alligator clip) and the polarity of the split core current transformer has to be left unchanged.

After values of R_{Ei} of all pylon foots are determined, the actual earth resistance R_E has to be calculated:

$$R_E = \frac{1}{\frac{1}{R_{E1}} + \frac{1}{R_{E2}} + \frac{1}{R_{E3}} + \frac{1}{R_{E4}}}$$

Note

If the displayed R_E value is negative despite correct orientation of the current transformer, a part of the measuring current is flowing upwards into the tower body. The earthing resistance, thus coming into effect, correctly calculates, if the individual equivalent resistances (under observation of their polarity) are inserted into the equation above.

Time average measurement:

If there is a warning "measured value unstable" (see "Description of displays", Procedure of Measurement) after a test sequence, most likely it is caused by strong interference signals (e.g. unsteady noise voltage).

Nevertheless, to get reliable values, the instrument offers the possibility of averaging over a longer period.

1. Select a fixed frequency (see "Control loop", Operation)
2. Keep the "START TEST" button pressed until the warning "measured value unstable" disappears. Max. averaging time is approx. 1. min.

Compensation of Earth Electrode Connecting Lead

If the line resistance to the earth electrode can not be ignored, a compensation of the connecting lead resistance to the earth electrode is possible. Proceed as described below:

Measuring process:

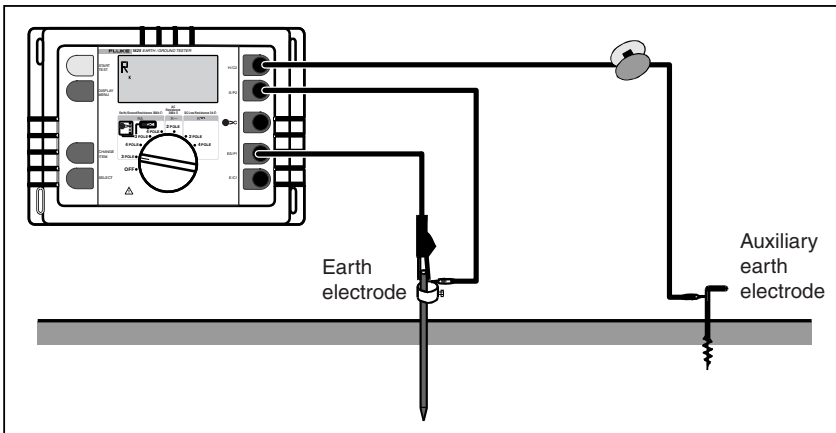

Figure 11. Compensation of Earth Electrode Connecting Lead

edw019.eps

1. Turn central rotary switch to position "R_E 3pole".
2. Wire instrument according to picture.
3. Call display R_K with "DISPLAY MENU" button.
4. Implement compensation with "START TEST" button.

The compensation resistance is displayed only for as long as the "START TEST" button is kept pressed. After releasing the "START TEST" button the measured value is stored and the measuring instrument returns to the standard settings at the beginning of the measurement so that a succeeding measurement

of the earthing resistance can be implemented by pressing "START TEST" again. Thereafter, R_K is subtracted from the actual measured value.

If the compensation value has to be reset to the basic setting (0.000Ω), the compensation sequence has to be implemented with an open (disconnected) measuring lead or turn the switch to the next position and back.

Measurement of Soil Resistivity

The soil resistivity is the geological and physical quantity for calculation and design of earthing systems. The measuring procedure applied below uses the method developed by Wenner (F. Wenner, A method of measuring earth resistivity; Bull. National Bureau of Standards, Bulletin 12 (4), Paper 258, S 478-496; 1915/16).

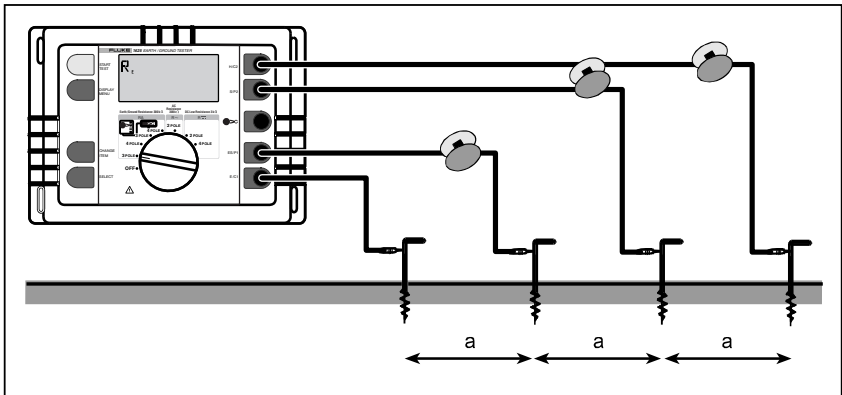

edw020.eps

Figure 12. Measurement of Soil Resistivity

1. Four earth spikes of the same length are positioned into the soil in an even line and with the same distance "a" to each other. The earth spikes should not be hammered in deeper than a maximum of $1/3$ of "a".
2. Turn central rotary switch to position " R_E 4pole".

The instrument is to be wired according to picture and notices given on the display.

A flashing of the sockets symbols E ES S H or Y D , points to an incorrect or incomplete connection of the measuring lead.

3. Push "START TEST" button.

4. Read out measured value R_E .

From the indicated resistance value R_E , the soil resistivity calculates according to the equation:

$$\rho_E = 2\pi.a.R_E$$

ρ_E mean value of soil resistivity (Ωm)

R_E measured resistance (Ω)

a probe distance (m)

The measuring method according to Wenner determines the soil resistivity down to a depth of approx. the distance "a" between two earth spikes. By increasing "a", deeper strata can be measured and checked for homogeneity. By changing "a" several times, a profile can be measured from which a suitable earth electrode can be determined.

According to the depth to be measured, "a" is selected between 2 m and 30 m. This procedure results in curves depicted in the graph below.

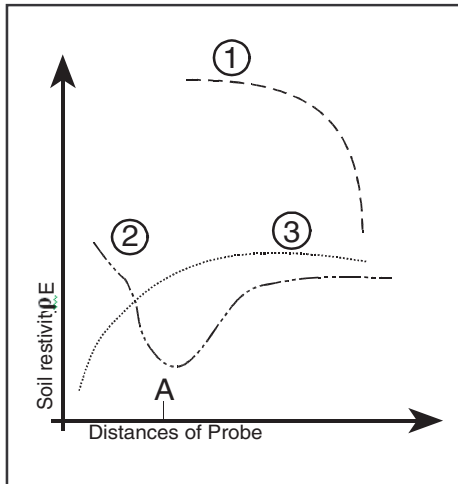

edw021.eps

Curve 1: As ρ_E decreases only deeper down, a deep earth electrode is advisable

Curve 2: As ρ_E decreases only down to point A, an increase in the depth deeper than A does not improve the values.

Curve 3: With increasing depth ρE is not decreasing: a strip conductor electrode is advisable.

As measuring results are often distorted and corrupted by underground pieces of metal, underground aquifers etc, a second measurement, in which the spike axis is turned by an angle of 90° , is always advisable (see picture).

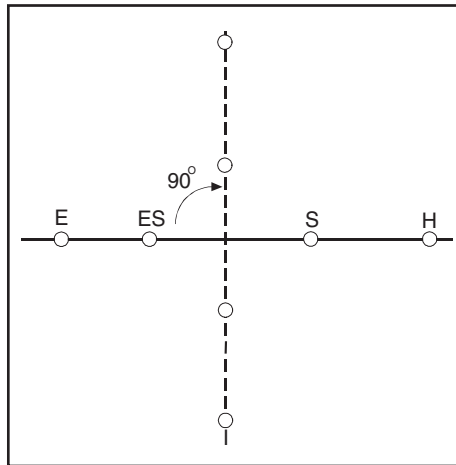

edw022.eps

Measurement of Resistances

Resistance Measurement (R_{\sim})

This measuring function determines the ohmic resistance between 0.001Ω and $300 \text{ k}\Omega$. The measurement is done with AC voltage. For measurements of very low resistances a compensation of the connecting leads is suggested (see “Compensation of Measuring Lead Resistance”).

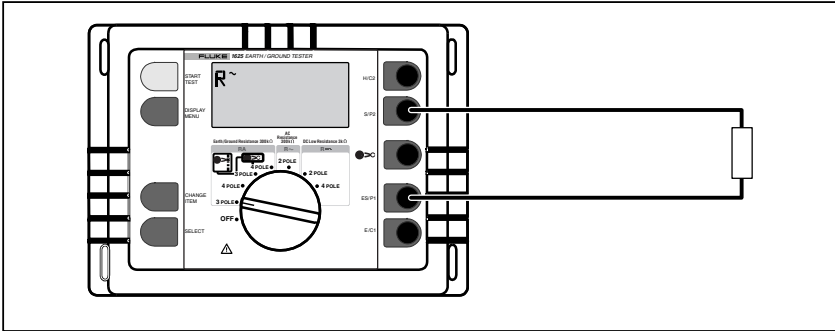

edw023.eps

Figure 13. Resistance Measurement (R~)

1. Turn central rotary switch to position "R~".
2. Connect instrument according to picture.
3. In this mode, all settings and LIMIT values available can be called with "DISPLAY MENU" and the measuring frequency can be set.
4. Press "START TEST" button.
5. Read out measured value.

Resistance measurement (R $\overline{\sim}$)

In this measuring mode all resistances from 0.001 Ω to 3 k Ω can be measured with DC voltage and automatic polarity reversal as per EN61557-5.

To achieve highest accuracy 4 pole measurements are possible. To balance the extension lead, a compensation has to be done.

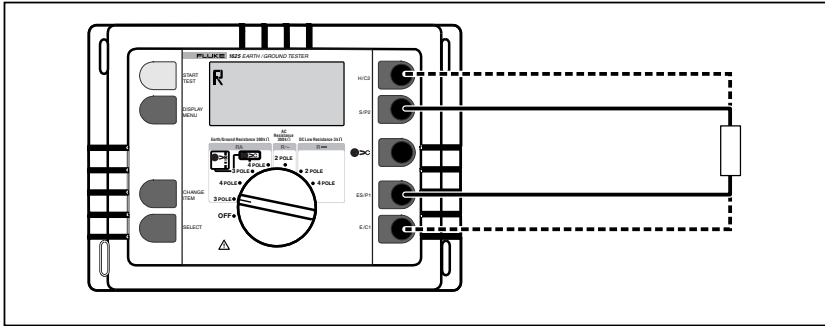

edw024.eps

Figure 14. Resistance measurement (R ∞)

1. Connect instrument according to picture.
2. Turn central rotary switch to position "R ∞ ".
3. In this mode, all settings and LIMIT values available can be called with "DISPLAY MENU".

⚠ Warning

Before starting a measurement bring plant or test object to off or de-energized circuit condition! With an external voltage higher than 3 V measurement will not be started.

⚠ Warning

Due to the high measuring current inductive loads can cause lethal induced voltages during disconnection from the measuring circuit.

4. Start measurement with "START TEST" button. First, "R₁" with positive voltage is measured on jack "E". After releasing the "START TEST" button "R₂" is measured with negative voltage on jack "E". The respectively higher measured value is displayed first.
5. The second measured value can be called with "DISPLAY MENU". If the set limit value (R LIMIT) is exceeded the limit can also be displayed.

Evaluation of measured value:

Taking into account the maximum operating error, the diagrams show the maximum admissible display values to be displayed so not to exceed the required resistance.

Measuring Range 29, 99 ... 299, 9 ... 2999 Ω

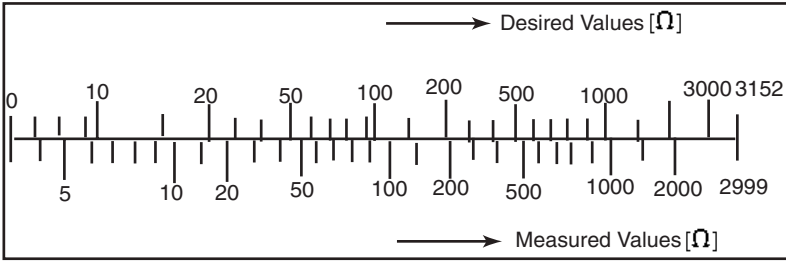

edw025.eps

Figure 15. Evaluation of Measured Value

Compensation of Measuring Lead Resistance

1. Call display of R_K with button "DISPLAY MENU".
2. Short circuit measuring lead according to picture.
3. Press "START TEST" button. Value R_K is stored after the release of the "START TEST" button, the display jumps back to voltage measurement. Thereafter, R_K is subtracted from the actual measured value. Turning the central rotary switch for a short moment deletes the line compensation again.

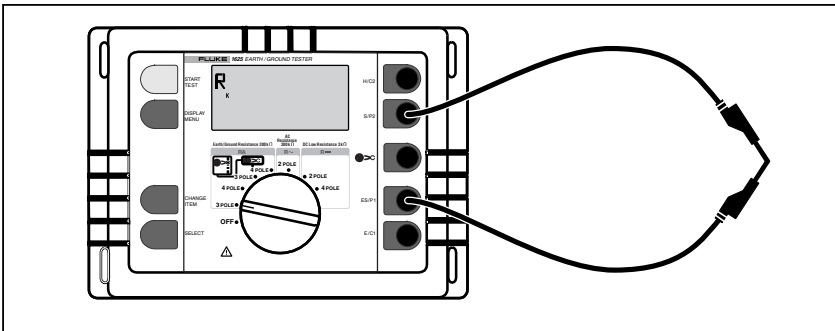











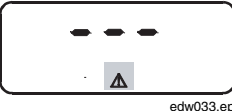
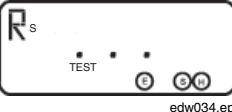
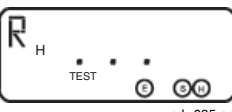

edw026.eps

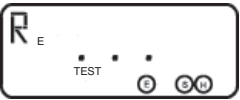
Figure 16. Compensation of Measuring Lead Resistance

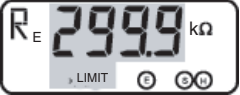

Description of Displays

Table 1. Description of Displays

Function	Displays	Condition	Note
Before "START"	 edw027.eps	Stand by position to reduce power consumption	Turn rotary switch or push button. All measured values remain stored
	 edw028.eps	No or incorrect measuring lead connection	Apart from voltage measurement all measuring functions are locked.
	 edw029.eps	Battery voltage too low	Replace batteries.
	 edw030.eps	Beeper on	Acoustical warning if limit is exceeded.
	 edw031.eps	Dangerous AC - voltage > 50 V	Apart from voltage measurement all measuring functions are locked.
Before "START"	 edw033.eps	Rotary switch in inter-mediate position	Select correct position.
After "START"	 edw034.eps	Probe resistance is being tested	Wait for test result.
	 edw035.eps	Aux. current spike- resistance is being tested.	Wait for test result.

Function	Displays	Condition	Note
	 <p>edw036.eps</p>	Earth resistance is being tested.	Wait for test result.
	 <p>edw037.eps</p>	Measuring circuit of earth and auxiliary earth electrode disconnected.	Check lead connection on earth spikes measuring lead might be defective.
	 <p>edw038.eps</p>	Measuring circuit of earth and probe electrode disconnected.	Check lead connection on earth spikes measuring lead might be defective.
	 <p>edw039.eps</p>	Max allowable error exceeded because of too high sense or aux earth spike resistance.	Try to moisten soil or connect 2nd aux earth spike in parallel.
After "START"	 <p>edw040.eps</p>	Measuring range exceeded.	Measured value is higher than 300 kΩ.
	 <p>edw041.eps</p>	Display of measured value exceeds LIMIT.	Measured value is higher than set LIMIT.
	 <p>edw042.eps</p>	Compensation higher than measured value.	Delete compensation or switch instrument ON/OFF.
	 <p>edw043.eps</p>	Wrong polarity on jacks E and ES.	Reverse polarity.

Earth/Ground Tester
Description of Displays

Function	Displays	Condition	Note
	 <p style="text-align: center; font-size: small;">edw044.eps</p>	Measured value instable.	Unsteady noise voltage. Try time average measurement.
	 <p style="text-align: center; font-size: small;">edw045.eps</p>	Current in external transformer to low.	Reduce auxiliary current spike resistance.
	<div style="border: 1px solid black; padding: 5px; text-align: center;"> No reactions to button control etc. </div> <p style="text-align: center; font-size: small;">edw046.eps</p>	Operation under faulty conditions.	Check batteries. Switch ON/OFF if still faulty, contact service.
After "START"	 <p style="text-align: center; font-size: small;">edw047.eps</p>	Reverse orientation of current clamp or "upwards" current.	Reverse clamp or see note on page 28.
	<div style="border: 1px solid black; padding: 5px; text-align: center;"> -E1- </div> <p style="text-align: center; font-size: small;">edw048.eps</p>	Checksum of EE PROM incorrect.	
	<div style="border: 1px solid black; padding: 5px; text-align: center;"> -E2- </div> <p style="text-align: center; font-size: small;">edw049.eps</p>	Hardware malfunction (e.g. current overload).	Switch ON/OFF if still faulty; The symbol may appear when using the stakeless measurement on low resistance circuits.
	<div style="border: 1px solid black; padding: 5px; text-align: center;"> -E3- </div> <p style="text-align: center; font-size: small;">edw050.eps</p>	EE PROM memory access malfunction.	contact service.
	<div style="border: 1px solid black; padding: 5px; text-align: center;"> -E4- </div> <p style="text-align: center; font-size: small;">edw051.eps</p>	Internal computation malfunction.	

Function	Displays	Condition	Note
	<p>edw052.eps</p>	Thermal over-load.	Cool thoroughly.
	<p>edw053.eps</p>	Battery voltage decreases at measurement.	The internal resistance of the batteries is too high (worn out, low temperature). Replace batteries, warm up instrument.
	<p>edw067.eps</p>	Polarity of CT's is reversed	Turn one CT
	<p>edw068.eps</p>	Resistance under test is below measuring range or adapter cable is plugged into ground tester incorrectly	Switch on/off for next test
	<p>edw069.eps</p>	Resistance under test is above measuring range	

Legend: = displayed flashing

Stakeless Earth/Ground Resistance Testing

Introduction

Stakeless testing provides the ground tester with the unique capability to measure individual ground resistances in multi-grounded systems using two clamp-on current transformers.

The use of ground stakes is not necessary.

Before this method was available, users were required to disconnect an individual ground path to be tested from other grounds to eliminate the influence of parallel ground paths.

This was time consuming at the minimum and in many cases dangerous.

Once disconnected, the standard 3-pole/terminal ground testing method was used which requires auxiliary earth stakes. In addition to consuming additional time, finding suitable locations for the ground stakes can be difficult and in some cases, impossible. The "stakeless" method of ground resistance testing eliminates these problems and ideally complements the ground testers' standard testing methods.

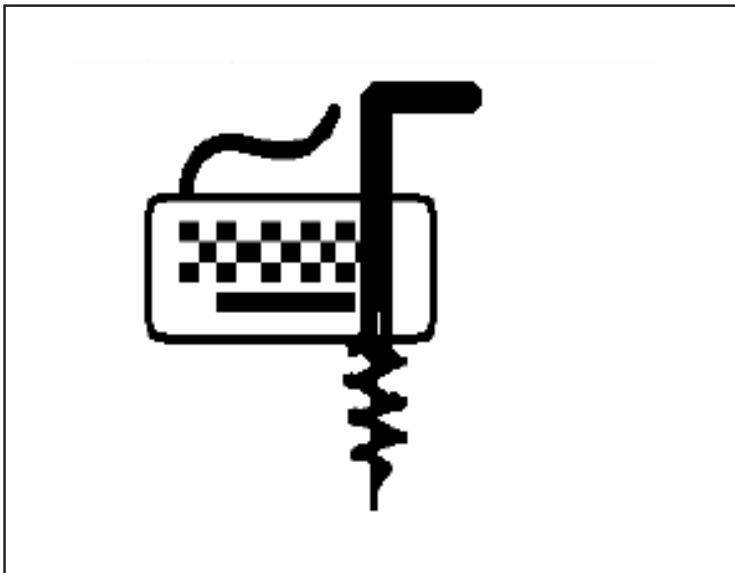

edw060.eps

Principle of Operation

Testing the resistances of individual ground connections in systems with parallel ground connections (multi-grounded systems).

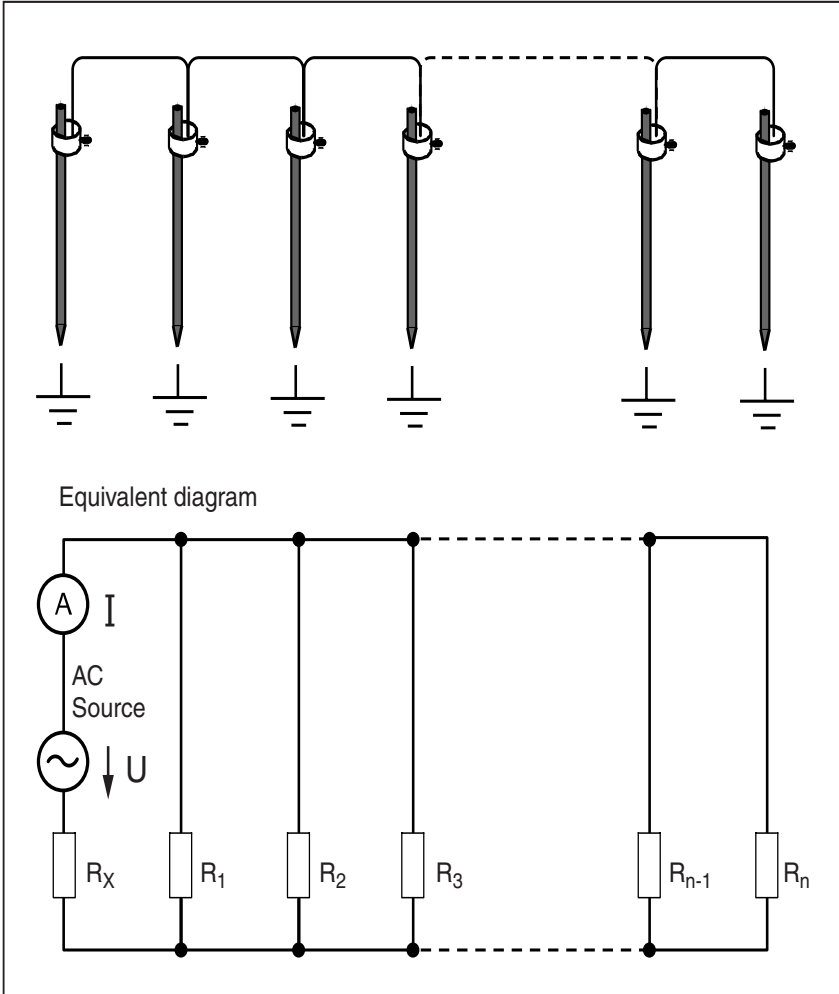

edw061.eps

$$\frac{U}{I} = R_x + \frac{1}{\frac{1}{R_1} + \frac{1}{R_2} + \dots + \frac{1}{R_n}}$$

If the parallel connection of resistors, $R_1 \dots R_n$ is considerably lower than the ground connection under test R_X :

$$\frac{1}{\frac{1}{R_1} + \frac{1}{R_2} + \dots + \frac{1}{R_n}} \ll R_X$$

then $R_X = \frac{U}{I}$ is a reasonable approximation.

The test voltage (U) is applied without disconnecting ground rod and/or the direct electrical connection by means of a clamp-on current transformer and the current detected by a second current transformer.

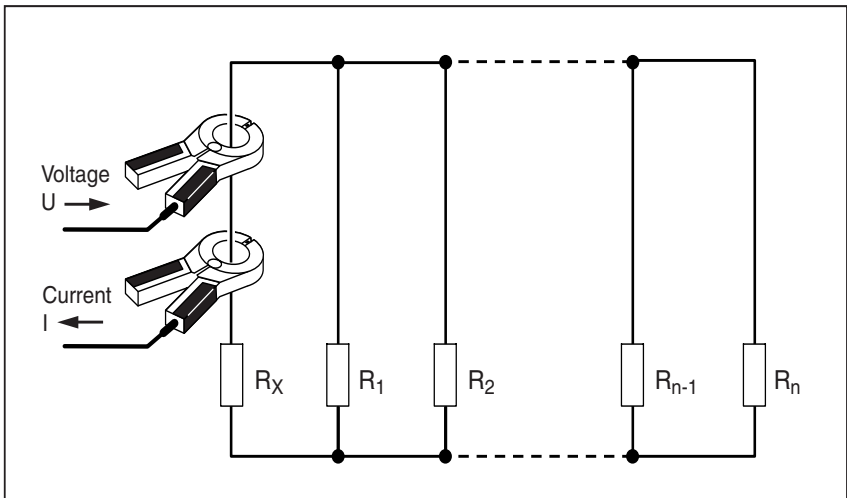

edw062.eps

After synchronous rectification of current and voltage the tester displays R_X .

Operation

Connect the adapter according to the diagram and the designations E, S and H (C1, P1 and P2 for US-version) to the tester and to a current clamp.

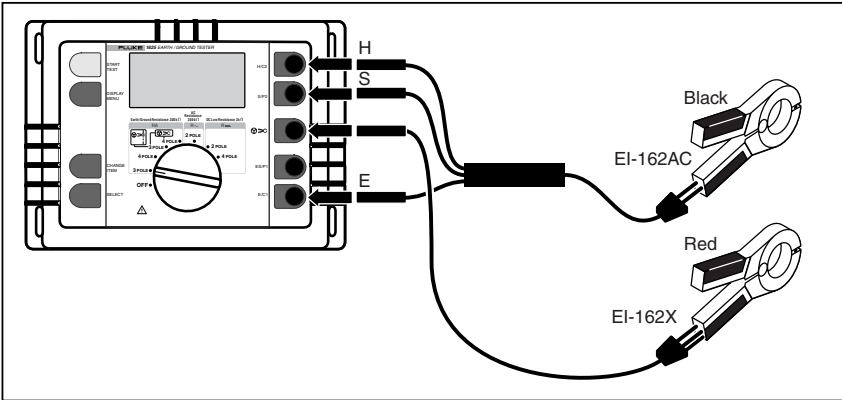

edw063.eps

Use the test cable contained in the set to connect the second current clamp to the socket. Ensure that connections are in the correct polarity. Turn the rotary switch of the tester to position **R_E** 3 pole.

Note

Use only current transformers referred to in this manual.

Clamp both transformers around the ground conductor to be tested.

Note

Try to have a distance > 10 cm between the clamps for optimal results.

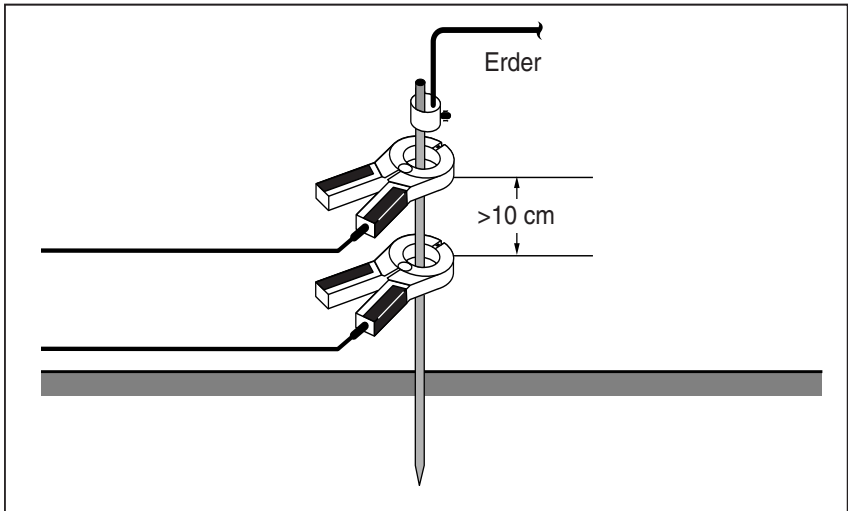

edw064.eps

Pushing the START-button will display the value of R_E .

Note

In this particular mode the values of R_H and R_S have no meaning.

Settings on the Tester

Refer to the *Operation* section in the Testers instruction manual.

The rotary switch of the tester must be in the R_E 3 pole position.

- U_m Set Test Voltage to 48 V (standard value)
- R_k Set compensation resistance to 0,000 Ohms
- I Set transformer ratio to 1000 (standard value)
- R^* Set to OFF (no meaning in this mode).

Applications

Example1 : Ground rod on power poles.

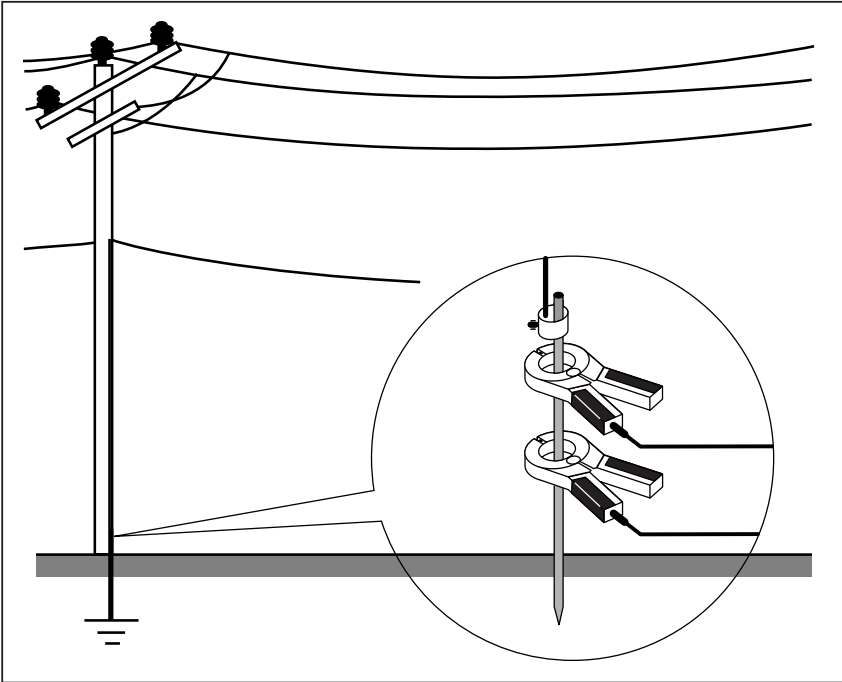

edw065.eps

Example 2: Tests on multi-grounded (inter-connected) systems:

Ground conductors are for example bonded to grids or concrete-footing grounds and other conducting elements such as lightning protection systems or frameworks.

In this case the resistances of individual ground paths are not of significance.

It must be tested if the resistance of the bonding is sufficiently low and reliable.

Earth/Ground Tester
Stakeless Earth/Ground Resistance Testing

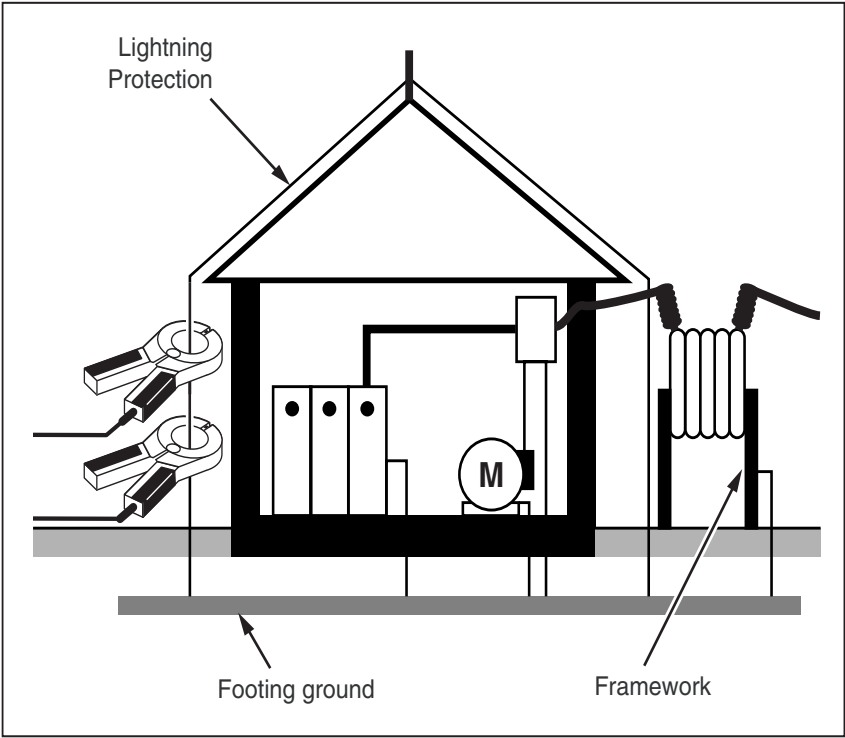

edw066.eps

